



#### Product Summary

$V_{(BR)DSS}$	$R_{DS(on)TYP}$	$I_D$
60V	0.9Ω@10V	0.34A
	1.1Ω@4.5V	

#### Feature

- Trench Technology Power MOSFET
- Low  $R_{DS(ON)}$
- Low Gate Charge
- ESD Protected

#### Application

- Load Switch
- DC/DC Converter

#### MARKING:

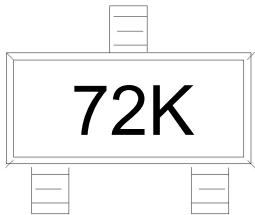

#### SOT-23

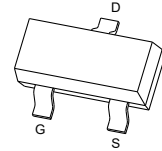

#### Schematic diagram

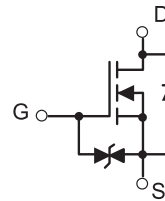

#### ABSOLUTE MAXIMUM RATINGS ( $T_A = 25^\circ\text{C}$ unless otherwise noted)

Parameter	Symbol	Value	Unit
Drain - Source Voltage	$V_{DS}$	60	V
Gate - Source Voltage	$V_{GS}$	±20	V
Continuous Drain Current <sup>1,5</sup>	$I_D$	0.34	A
Pulsed Drain Current <sup>2</sup>	$I_{DM}$	1.0	A
Power Dissipation <sup>4,5</sup>	$P_D$	0.35	W
Thermal Resistance from Junction to Ambient <sup>5</sup>	$R_{\theta JA}$	357	°C/W
Junction Temperature	$T_J$	150	°C
Storage Temperature	$T_{STG}$	-55~ +150	°C

**MOSFET ELECTRICAL CHARACTERISTICS (T<sub>A</sub> = 25°C unless otherwise noted)**

Parameter	Symbol	Test Condition	Min	Type	Max	Unit
<b>Off Characteristics</b>						
Drain - Source Breakdown Voltage	V <sub>(BR)DSS</sub>	V <sub>GS</sub> = 0V, I <sub>D</sub> = 250μA	60			V
Zero Gate Voltage Drain Current	I <sub>DSS</sub>	V <sub>DS</sub> = 48V, V <sub>GS</sub> = 0V			1	μA
Gate - Body Leakage Current	I <sub>GSS</sub>	V <sub>GS</sub> = ±20V, V <sub>DS</sub> = 0V			±5	μA
<b>On Characteristics<sup>3</sup></b>						
Gate Threshold Voltage	V <sub>GS(th)</sub>	V <sub>DS</sub> = V <sub>GS</sub> , I <sub>D</sub> = 250μA	1	1.5	2.5	V
Drain-source On-resistance	R <sub>DS(on)</sub>	V <sub>GS</sub> = 10V, I <sub>D</sub> = 0.3A		0.9	2.5	Ω
		V <sub>GS</sub> = 4.5V, I <sub>D</sub> = 0.2A		1.1	3	
<b>Dynamic Characteristics</b>						
Input Capacitance	C <sub>iss</sub>	V <sub>DS</sub> = 30V, V <sub>GS</sub> = 0V, f = 1MHz		23.7		pF
Output Capacitance	C <sub>oss</sub>			5.3		
Reverse Transfer Capacitance	C <sub>rss</sub>			2.5		
Gate Resistance	R <sub>g</sub>	V <sub>DS</sub> = 0V, V <sub>GS</sub> = 0V, f = 1MHz		160		Ω
<b>Switching Characteristics</b>						
Total Gate Charge	Q <sub>g</sub>	V <sub>DS</sub> = 30V, V <sub>GS</sub> = 10V, I <sub>D</sub> = 0.3A		0.29		nC
Gate-source Charge	Q <sub>gs</sub>			0.23		
Gate-drain Charge	Q <sub>gd</sub>			0.12		
Turn-on Delay Time	t <sub>d(on)</sub>	V <sub>DD</sub> = 30V, V <sub>GS</sub> = 10V, R <sub>L</sub> = 100Ω, R <sub>G</sub> = 3Ω		3.5		ns
Turn-on Rise Time	t <sub>r</sub>			3.2		
Turn-off Delay Time	t <sub>d(off)</sub>			12		
Turn-off Fall Time	t <sub>f</sub>			10		
<b>Source - Drain Diode Characteristics</b>						
Diode Forward Voltage <sup>3</sup>	V <sub>SD</sub>	V <sub>GS</sub> = 0V, I <sub>S</sub> = 0.3A			1.2	V

**Notes :**

- 1.The maximum current rating is limited by package.
- 2.Pulse Test : Pulse Width ≤ 10μs, duty cycle ≤ 1%.
- 3.Pulse Test : Pulse Width ≤ 300μs, duty cycle ≤ 2%.
- 4.The power dissipation P<sub>D</sub> is limited by T<sub>J(MAX)</sub> = 150°C.
- 5.Device mounted on 1in<sup>2</sup> FR-4 board with 2oz. Copper, in a still air environment with T<sub>A</sub> =25°C.

## Typical Characteristics

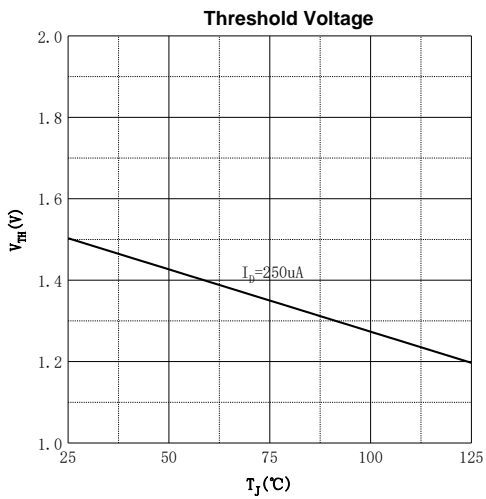
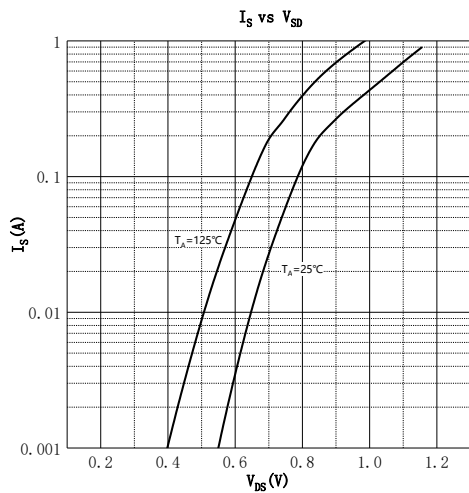
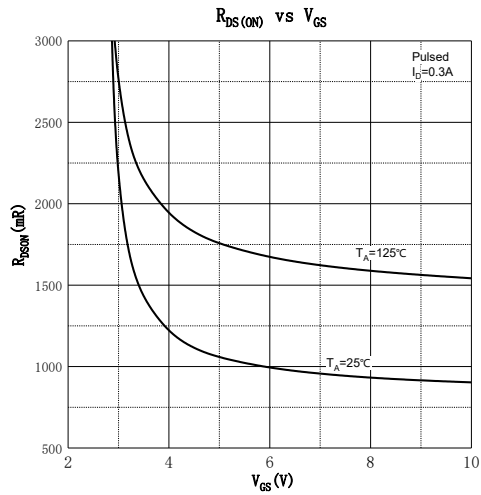
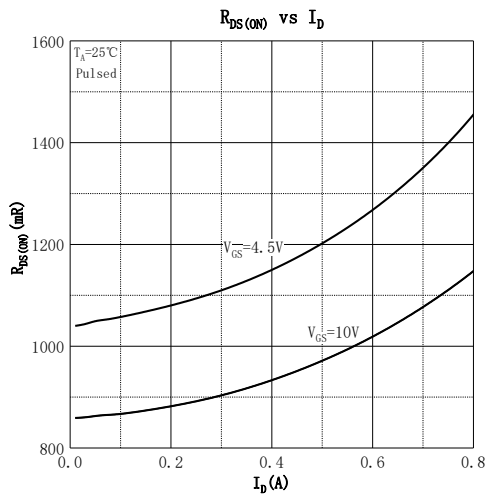
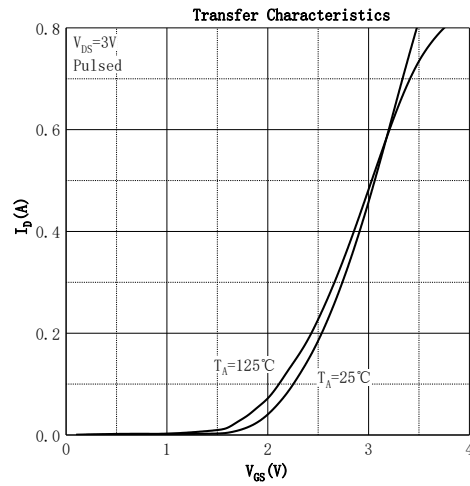
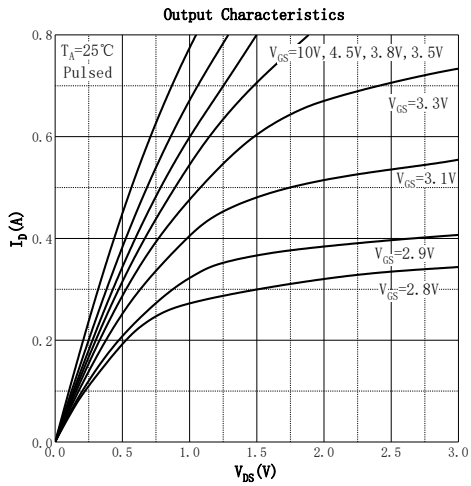

## SOT-23 Package Information

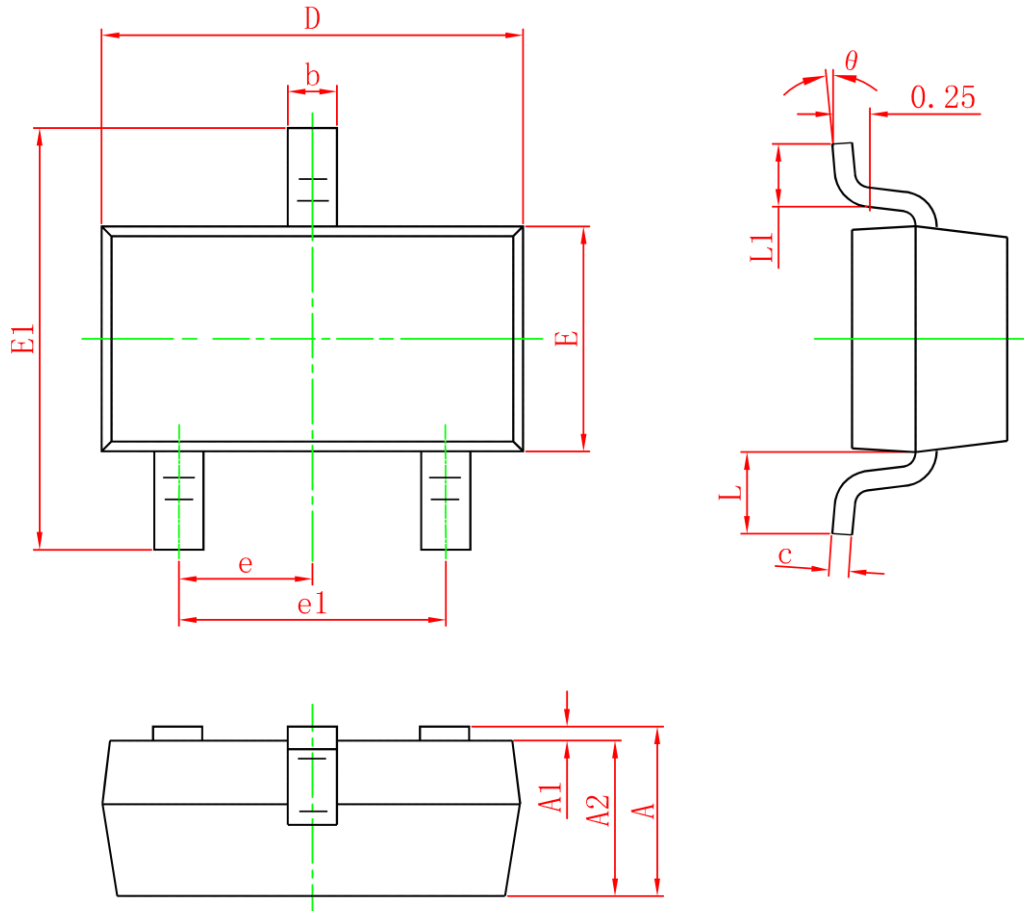

Symbol	Dimensions In Millimeters		Dimensions In Inches	
	Min.	Max.	Min.	Max.
A	0.900	1.150	0.035	0.045
A1	0	0.100	0	0.004
A2	0.900	1.050	0.035	0.041
b	0.300	0.500	0.012	0.020
c	0.080	0.150	0.003	0.006
D	2.800	3.000	0.110	0.118
E	1.150	1.500	0.045	0.059
E1	2.250	2.650	0.089	0.104
e	0.950TYP		0.037TYP	
e1	1.800	2.000	0.071	0.079
L	0.550REF		0.022REF	
L1	0.300	0.500	0.012	0.020
$\theta$	0°	8°	0°	8°